

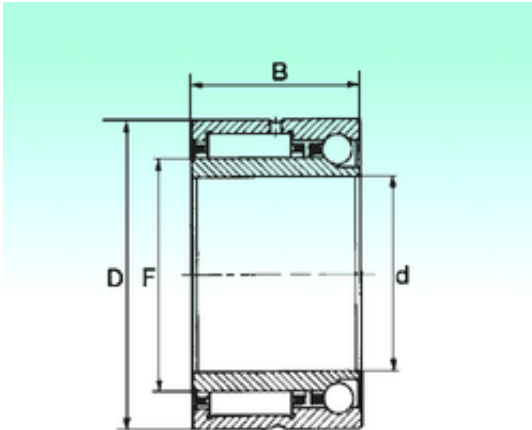

Bearing equipment manufacturing Co., Ltd



NKIA 5902 Bearing 2D drawings and 3D CAD models

15 mm x 28 mm x 18 mm NBS NKIA 5902
complex bearings

Bearing No. NKIA 5902

Size	15x28x18 mm
Bore Diameter	15 mm
Outer Diameter	28 mm
Width	18 mm
d	15 mm
F	20 mm
D	28 mm
B	18 mm
C	18 mm
Weight	0,05 Kg
Dynamic load rating radial (C)	10,07 kN
Dynamic load rating axial (C)	2,223 kN
Static load rating radial (C0)	12,9 kN
Static load rating axial (C0)	2,613 kN