

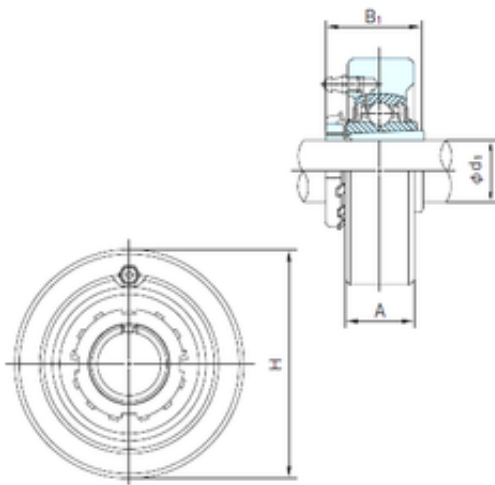

Bearing equipment manufacturing Co., Ltd



NACHI UKC317+H2317 bearing units

Bearing No. UKC317+H2317

Bore Diameter	75 mm
Width	215 mm
d	75 mm
A	64 mm
B1	82 mm
H	215 mm

UKC317+H2317 Bearing 2D drawings and 3D CAD models