

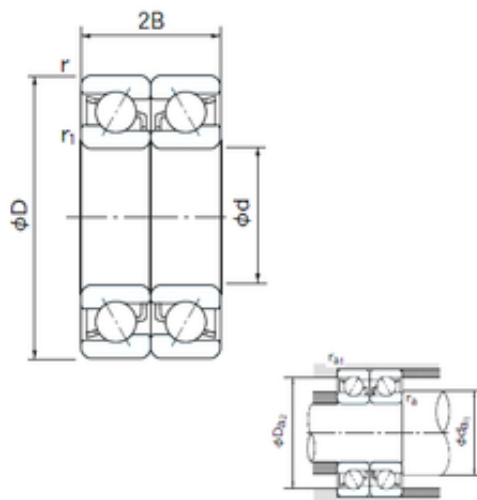

## Bearing equipment manufacturing Co., Ltd



200 mm x 360 mm x 58 mm NACHI 7240BDB  
angular contact ball bearings

Bearing No. 7240BDB

7240BDB Bearing 2D drawings and 3D CAD models

Size	200x360x58 mm
Bore Diameter	200 mm
Outer Diameter	360 mm
Width	58 mm
d	200 mm
D	360 mm
B	58 mm
C	58 mm
Angle ( ° )	40 °
a	88.5 mm
r min.	4 mm
r1 min.	1.5 mm
2B	116 mm
da min.	209 mm
Da max.	351 mm
ra max.	1.5 mm
Weight	25.5 Kg
Basic dynamic load rating (C)	510 kN
Basic static load rating (C0)	840 kN
(Grease) Lubrication Speed	1000 r/min
Bore Type	Cylindrical Bore
Enclosure	Open
Configuration	Duplex
Bore Size	200 mm
Outside Diameter	360 mm



## Bearing equipment manufacturing Co., Ltd

Width	58 mm
Fillet Radius/Chamfer	4 mm
r1	1.5 mm
Dynamic Load Rating	510,000 N
Static Load Rating	840,000 N
Limiting Speed - Grease	1,000 rpm
Limiting Speed - Oil	1,500 rpm
da1 (min)	218 mm
da2 (min)	209 mm
Da1 (max)	342 mm
Da2 (max)	351 mm
ra (max)	3 mm
ra1 (max)	1.5 mm