

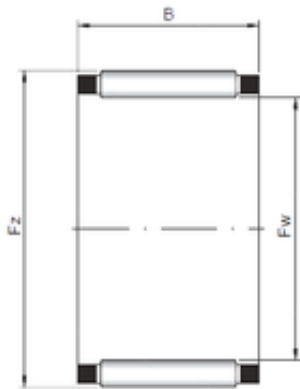

Bearing equipment manufacturing Co., Ltd

ISO K05x08x08 needle roller bearings



Bearing No. K05x08x08

Size	5x8x8 mm
Bore Diameter	5 mm
Outer Diameter	8 mm
Width	8 mm
Fw	5 mm
Ew	8 mm
B	8 mm

K05x08x08 Bearing 2D drawings and 3D CAD models