

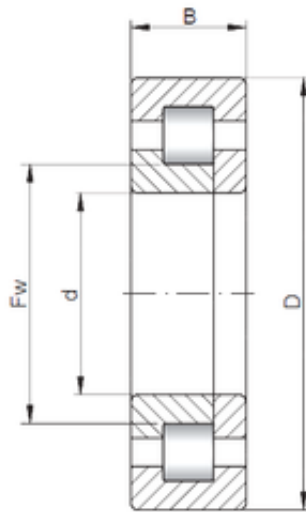

Bearing equipment manufacturing Co., Ltd



220 mm x 400 mm x 65 mm ISO NUP244
cylindrical roller bearings

Bearing No. NUP244

Size	220x400x65 mm
Bore Diameter	220 mm
Outer Diameter	400 mm
Width	65 mm
d	220 mm
D	400 mm
B	65 mm
C	65 mm

NUP244 Bearing 2D drawings and 3D CAD models